

Article number: 51836325100010

Description: Vibration damper GMF 62/30

Measures

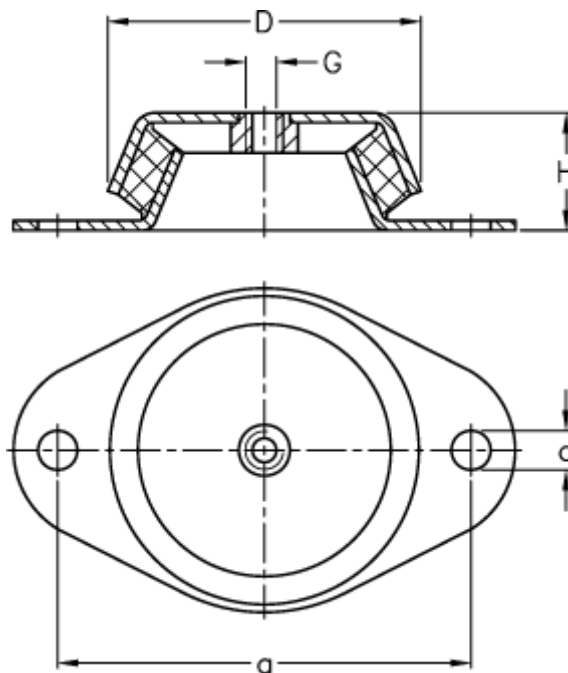

a	= 85
D	= 62
d	= 8.2
G	= M10
H	= 30
Load (daN)	= 200